

Lubrina 2

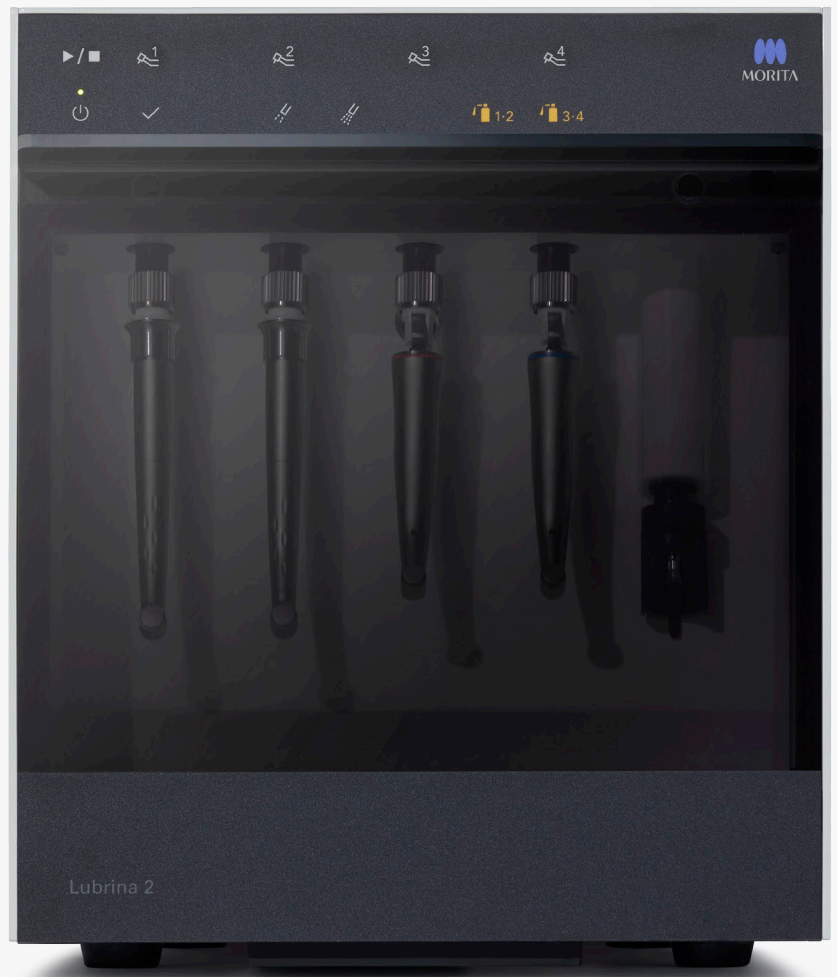

Seamless Auto-Maintenance

Fast and clean operation, plus compatibility with multiple brands of spray lubricant

Lubrina 2 automatically performs maintenance (lubrication and cleaning) of handpieces which are essential for daily practice. Because the lubrication amount and service time suitable for each handpiece are programmed into Lubrina 2, it can automatically perform maintenance of up to four handpieces in a short time. The clean air-blow system implements lubrication and cleaning of the inside of the handpiece thoroughly, and provides stable maintenance without variations by staff which can occur during manual lubrication. Lubrina 2 accepts multiple brands of spray lubricant.



Cleans one turbine in approximately 20 seconds

Oil usage amount is reduced to 1/4

Faster maintenance with excellent cost savings

Since the air-blow system can remove residual water completely using clean air, the efficiency of lubrication is enhanced with oil usage only 1/4 of that compared to manual lubrication. Daily maintenance cost is therefore reduced. In addition, the system can remove surplus oil effectively, allowing maintenance in a short time*¹.

Greatly shortens the maintenance process

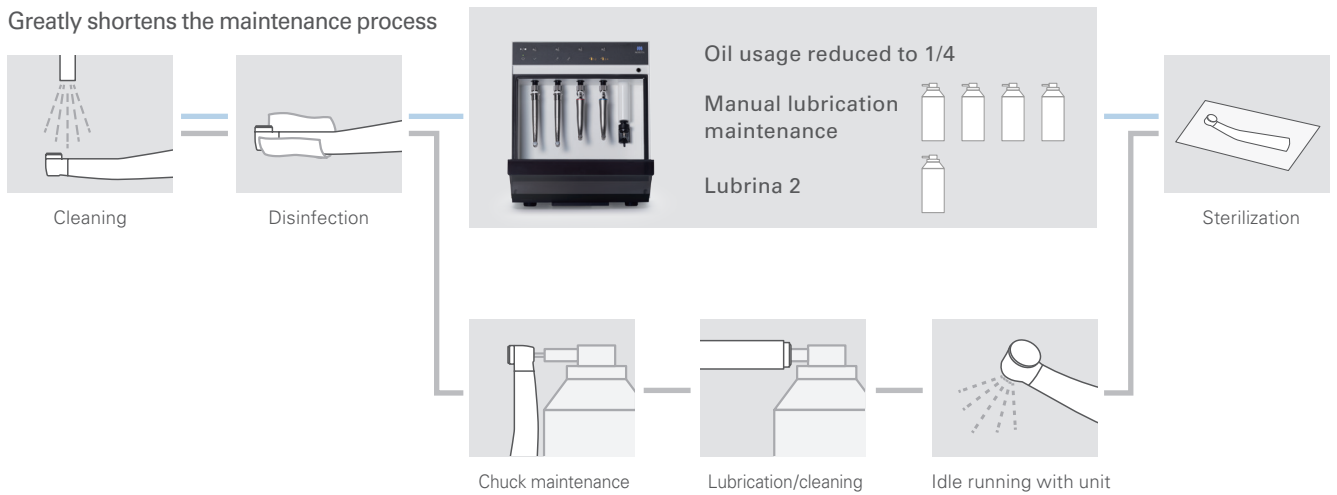

Maintenance of one turbine in approximately 20 seconds

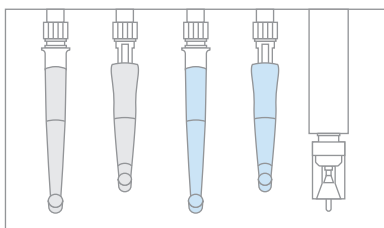
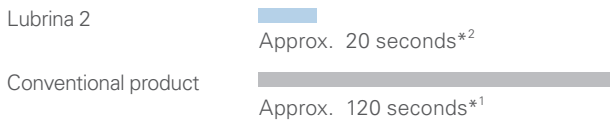

Example: One turbine and contra angle by Morita and one turbine and contra angle by another manufacturer.



Handpiece and spray compatibility

By replacing the coupling, Lubrina 2 facilitates the maintenance of Tri Auto ZX2 and Dentaport ZX contra-angles, air driven handpieces (ISO 9168/Type 3 joint) as well as all contra-angles and straight handpieces (ISO 3964/E-Type joint). Lubrina 2 is compatible with 4-hole, 5-hole, and 6-pin connections. With its dual lubrication system, one or two different brands of spray may be used in the same cycle. Several brands of spray are compatible by using an optional spray holder adapter.

*1 Comparison with the long mode of our previous Lubrina
 *2 Approximately 40 seconds for contra-angle handpiece

Clean Air-Blow System

Double-conduit design achieves clean air

The double-conduit design allows the clean air-blow system to achieve clean air. By employing the dual solenoid valves and clean air dedicated conduit, the system can supply clean air without a mix of oil. During the water removal process before lubrication, the system removes the water in the head which maximizes lubrication results. During idling after lubrication, the surplus oil can be effectively removed by clean air.

Lubrina 2 (Clean Air-Blow System)

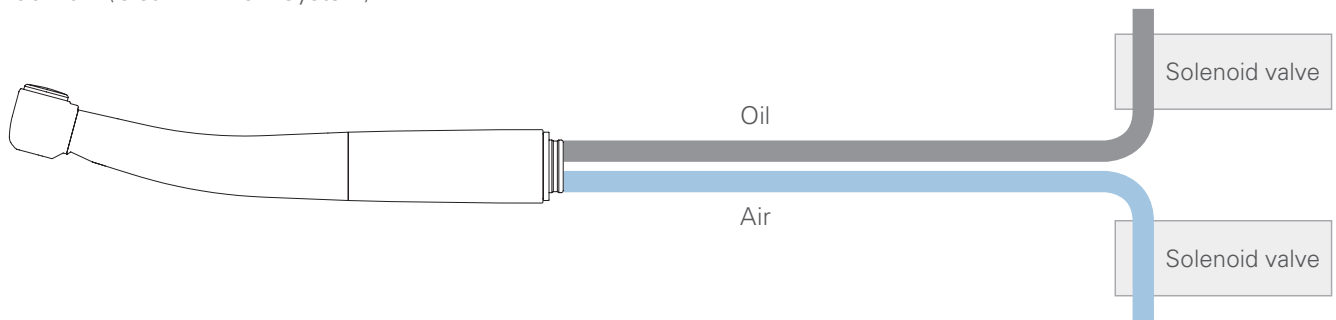

Conventional product*

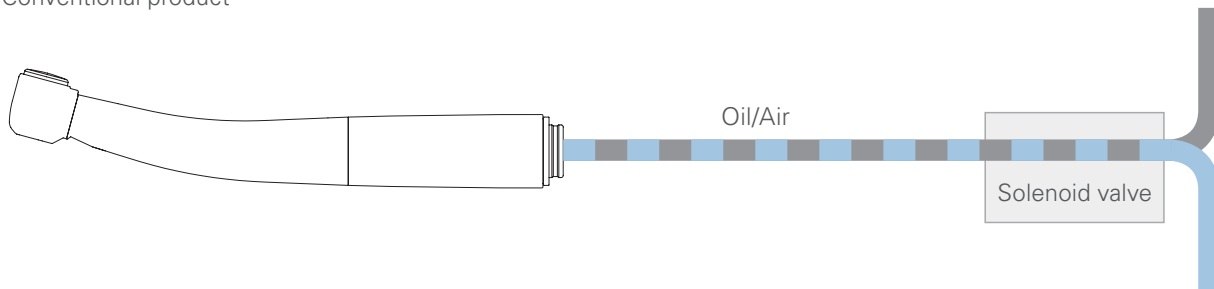

* Original Lubrina Handpiece Maintenance System

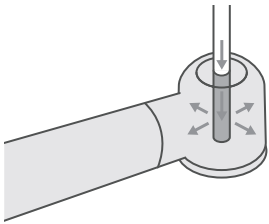

Easy chuck maintenance
 For the turbine and 5x speed contra-angle handpiece, it is essential to lubricate and clean the chuck which holds the bar. The built-in one-touch chuck maintenance mechanism allows for easy maintenance.

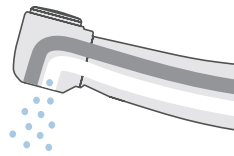

Water removal during autoclaving

If autoclave is performed while a large amount of water is left in the conduit of the handpiece, steam will not infiltrate and could cause a sterilization defect. To prevent this, clean air (without a mix of oil) is fed into the water feed, chip air conduit to remove the residual water, thereby reducing the possibility of a problem during autoclaving.

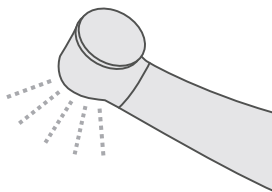

Surplus oil removal reduces idling time before practice

During handpiece rotation, clean air removes the surplus oil which causes blow-out, and thus reduces the idling time necessary before use.

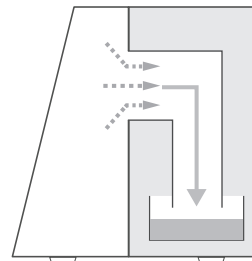

Reduces scattering of oil mist

The built-in oil mist suction mechanism draws in the oil mist generated during maintenance, thereby preventing the mist from scattering to nearby surfaces and devices. In addition, since oil mist is collected into the oil gathering tray, maintenance of the equipment is also easy.

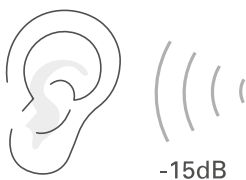

Reduced operating sound
 Lubrina 2 offers a noise reduction of 15dB during operation compared to the original model.

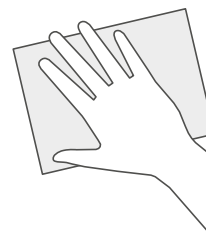

Easy maintenance
 The control panel is flat for easy cleaning, and the front door can also be removed for improved access.

Features

Compatible with multiple brands

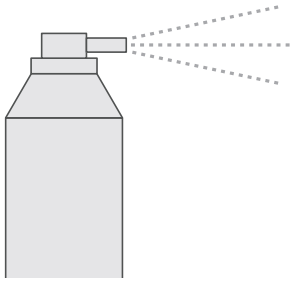







Oil spray can delivery system
The low viscosity oil mist penetrates into the inside of the handpiece head and delivers intense cleaning.

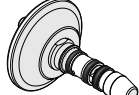

Morita Multi Spray (sold separately)

This dedicated oil offers excellent lubrication properties and enhances the performance of TwinPower Turbine and TorqTech.

Optional Items

Coupling	Target device		
Alpha Coupling Code No.: 7376766 	TwinPower Turbine p, TwinPower Turbine s	4H Coupling Code No.: 7376715 	TwinPower Turbine 4H
KaVo Coupling Code No.: 7376723 	KaVo MULTIflex, KaVo MULTIflex LUX	Sirona Coupling Code No.: 7376731 	Sirona R/F
W&H Coupling Code No.: 7376758 	W&H Roto Quick	LS Coupling Code No.: 7376774 	Handpieces, TorqTech and devices with a connection type that comply with ISO3964 (JIS T5904)
TR-ZX2/DP Coupling Code No.: 7376782 	Tri-Auto ZX2, Tri-Auto mini, Dentaport ZX	Tri-Auto ZX Coupling Code No.: 7373325 	Tri-Auto ZX

Spray Holder Spray Holder (standard)	Conforming Spray Morita Multi Spray (LS Spray, AR Spray)
Spray Holder (KaVo/NSK for Pana/Yoshida) Spray Holder (for W&H)	KaVo Spray, NSK PANA SPRAY Plus, YOSHIDA Spray W&H SERVICE Oil F1
Spray Holder (for Sirona)	Sirona T1 Spray
Spray Morita Multi Spray	

* The company names and product names are trademarks or registered trademarks of each company.

Specifications

Brand name: Lubrina 2
Model: HIM-2
Power voltage: AC 100V-240V 50-60Hz
Power consumption: 10-25 VA
Maximum input air pressure: 0.7 MPa max.
Air pressure used: 0.3-0.5 MPa (recommended 0.4 MPa)
Consumed air flow rate: 60-100 NL / min (0.3-0.5 MPa)

Weight: Approx. 8 kg
External dimensions: W300×D300×H365mm
Manufactured and sold by: J. MORITA MFG. CORP.

Functions

Clean Air-blow System (Dual solenoid valves)
Mode 1 (for turbine)
Mode 2 (for contra-angle handpiece)
Flushing mode
Air-blow mode
Chuck maintenance mechanism
Spray can system
Dual spray system
Residual water removal mechanism
Oil mist suction mechanism
Compatible with handpieces manufactured by various companies

Accessories

Oil absorption pad
Oil absorption sheet
Oil absorption sheet for front door
Sheet stopper for door
Power supply cord
Air tube
Spray Holders (standard) x 2
(for Morita Multi Spray)
* Lubrina 2 is not provided with couplings.

Dimensional outline drawing / Installation clearances (mm)

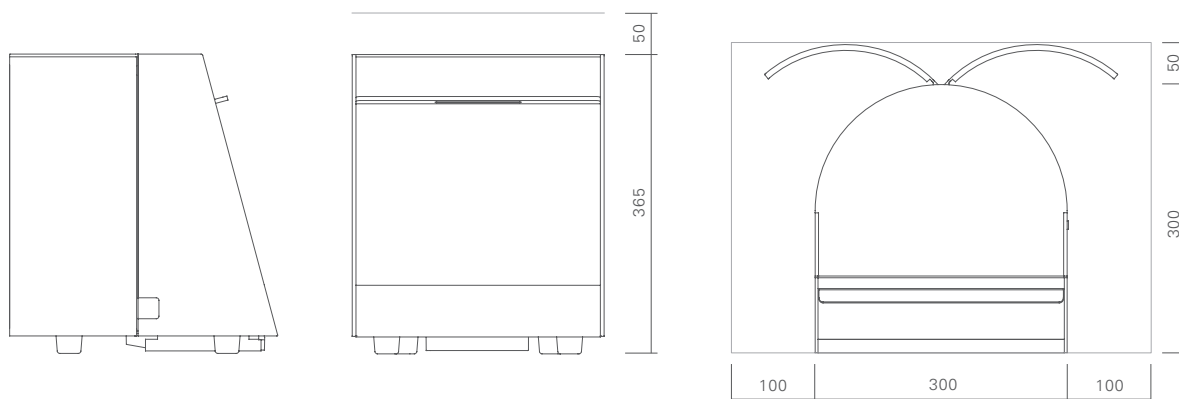



Development and Manufacturing

J. MORITA MFG. CORP.

680 Higashihama Minami-cho, Fushimi-ku,
Kyoto 612-8533, Japan
T +81. (0)75. 611 2141, F +81. (0)75. 622 4595

Morita Global Website

www.morita.com

Distribution

J. MORITA CORP.

3-33-18 Tarumi-cho, Suita-shi, Osaka 564-8650, Japan
T +81. (0)6. 6380 1521, F +81. (0)6. 6380 0585

J. MORITA USA, INC.

9 Mason, Irvine CA 92618, USA
T +1. 949. 581 9600, F +1. 949. 581 8811

J. MORITA EUROPE GMBH

Justus-von-Liebig-Strasse 27a, 63128 Dietzenbach, Germany
T +49. (0)6074. 836 0, F +49. (0)6074. 836 299

MORITA DENTAL ASIA PTE. LTD.

150 Kampong Ampat
#06-01A KA Centre, Singapore 368324
T +65. 6779. 4795, F +65. 6777. 2279

J. MORITA CORP. AUSTRALIA & NEW ZEALAND

Suite 2.05, 247 Coward Street, Mascot NSW 2020, Australia
T +61. (0)2. 9667 3555, F +61. (0)2. 9667 3577

J. MORITA CORP. MIDDLE EAST

4 Tag Al Roasaa, Apartment 902, Saba Pacha 21311 Alexandria, Egypt
T +20. (0)3. 58 222 94, F +20. (0)3. 58 222 96

J. MORITA CORP. INDIA

Filix Office No.908, L.B.S. Marg, Opp. Asian Paints, Bhandup (West), Mumbai 400078, India
T +91-22-2595-3482

J. MORITA MFG. CORP. INDONESIA

28F, DBS Bank Tower, Jl. Prof. Dr. Satrio Kav. 3-5, Jakarta 12940, Indonesia
T +62-21-2988-8332, F + 62-21-2988-8201

SIAMDENT CO., LTD.

71/10 Mu 5, Thakham, Bangpakong, Chachuengsao 24130, Thailand
T +66. 38. 573042, F +66. 38. 573043
www.siamdent.com

Diagnostic and Imaging Equipment

Treatment Units

Handpieces and Instruments

Endodontic System

Laser Equipment

Laboratory Devices

Educational and Training Systems

Auxiliaries